



ETRO

Home Interiors

Available at:

PALAZZO COLLEZIONI

[www.palazzocollezioni.com.au](http://www.palazzocollezioni.com.au)



ETRO

Home Interiors

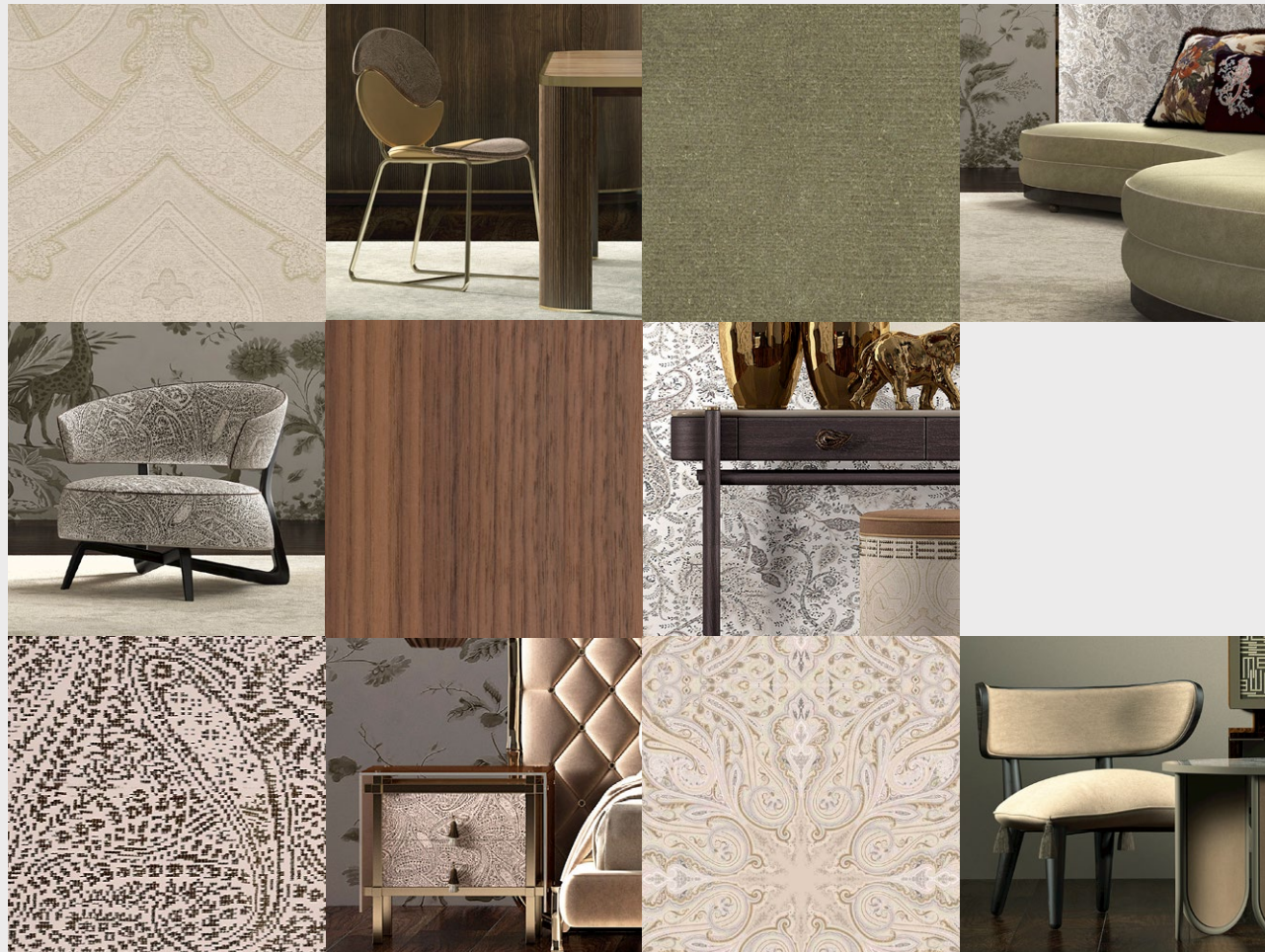

PREVIEW  
2022





















# LIVING ROOM



# MEKONG SOFA

Mekong is a sofa with a singular style, where the exotic references and the contemporary allure that have always distinguished the ETRO Home Interiors line are combined with the 1950s vintage-inspired design and refined classic references. A mix of allusions that confirms the brand's eclecticism.

Generous, welcoming and comfortable, Mekong is an invitation to relaxation and conviviality. The sage green velvet upholstery dresses the sofa with a sophisticated luxury that evokes the Parisian pastry shops and cafes of the late 19th century. A delicate reference to classicism reinterpreted in a contemporary key, as evident in the presence of original decorative elements, such as the spheres used as feet. The curved lines of the sofa recall the fluidity and dynamism of a flowing river – a reference already present in the name – and are combined with the precious essence of dark Carbalho wood, used for the base of the sofa.

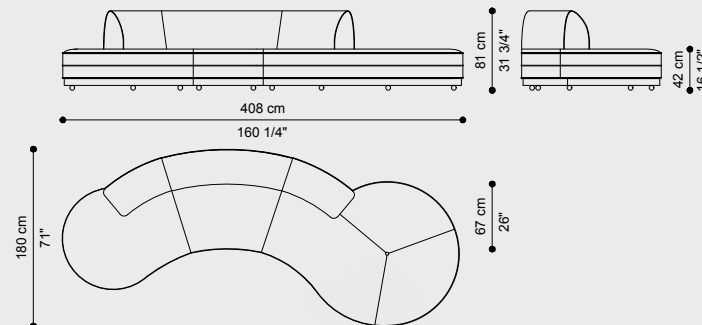

**E.MEK.211.D**

4-seater right

**E.MEK.211.C**

4-seater left



Velvet GENOVA  
col. 2 Sage  
cat. A



Velvet GENOVA  
col. 1 Rice  
cat. A



MATT DARK WENGÉ  
DYED CARBALHO  
VENEERED

**E.MEK.211.DDG**

4-seater sofa

## COMPOSITION

Curved 4-seater sofa with structure in multilayer wood and variable thickness high density expansive polyurethane foam. Seat upholstered in velvet cat. A Genova col. 2 Sage with piping in velvet cat. A Genova col. 1 Rice.

Base in multilayer wood veneered in matt Dark Wengé Dyed Carbalho. Spherical feet in solid beech wood lacquered Brushed Dark Bronze.



**E.EHC.822.GMX**

CORELLA lilac  
L 60 D 60 cm



**E.EHC.822.HMX**

SOMERSET light green  
L 45 D 45 cm



**E.EHC.822.KMX**

SOMERSET beige  
L 45 D 45 cm



**E.EHC.821.BMX**

CASSEAUX burgundy  
L 45 D 45 cm



**E.EHC.821.KMX**

CHOBE beige  
L 45 D 45 cm



**E.EHC.822.NMX**

PETS beige  
L 45 D 45 cm

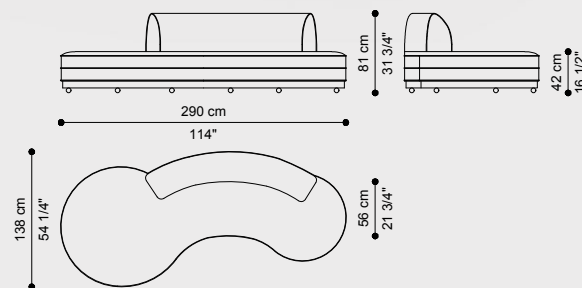

**E.MEK.211.B**

3-seater right

**E.MEK.211.A**

3-seater left

# DIANA ARMCHAIR

*Elegant, enveloping and comfortable, the Diana armchair celebrates the eclectic and versatile soul of the ETRO Home Interiors line. The vintage structure with a 50s inspired design is made of solid wood in dark wengé colour and is enhanced by the Paisley fabric, presented in a new light shade with a hint of brown that fits perfectly in a relaxed living space.*



Jacquard fabric ZULU  
col. 3 Sand  
cat. A

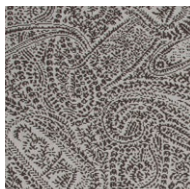

PIPING

Velvet VENEZIA  
col. 17 Moka  
cat. A

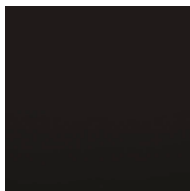

MATT DARK WENGÉ  
DYED WOOD

**E.DIA.228.ADX**

## COMPOSITION

Armchair with structure in solid beech wood dyed matt Dark Wengé, turned and worked with a numeric control system.

Seat in multilayer wood and variable thickness high density expansive polyurethane foam. Upholstery in jacquard fabric cat. A Zulu col. 3 Sand. Piping in velvet cat. A Venezia col. 17 Moka.

Backrest in curved multilayer wood and variable thickness high density expansive polyurethane foam. Upholstery in jacquard fabric cat. A Zulu col. 3 Sand. Piping in velvet cat. A Venezia col. 17 Moka.

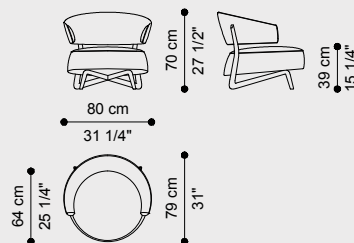

# MERIAM POUF

*A decorative piece of furniture with exotic suggestions, Meriam pouf is presented with velvet upholstery and embellished with golden studs and a fluted gold lacquered base.*

Velvet VENEZIA  
col. 17 Moka  
cat. A

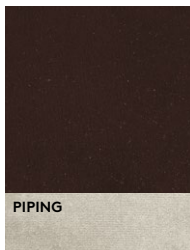

PIPING

Velvet GENOVA  
col. 1 Rice  
cat. A



SEMI-GLOSSY  
GOLD LACQUERED



**E. MEI. 222. ADX**

## COMPOSITION

Pouf with structure in multilayer wood and variable thickness high density expansive polyurethane foam. Upholstery in velvet cat. A Venezia col. 17 Moka with piping in velvet cat. A Genova col. 1 Rice. Decoration with ETRO motif with golden nails. Base in Gold Lacquered MDF, grooved with a numeric control system.

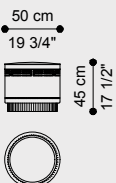

# AXUM LOW TABLES

*Nomadic inspiration and ethnic accents. Axum is a sophisticated table imbued with an African atmosphere, expressed in the matte dark wengé wood of the structure and in the polished brass rings reminding. The top in Dark Wengé Dyed Carbalho wood completes this wonderful piece of furniture in perfect ETRO Home Interiors style.*



**E.AXU.231.AGX**

Ø 122 cm

**E.AXU.232.AGX**

L 63 cm

## COMPOSITION

Low tables with structure in solid beech wood dyed matt Dark Wengé, turned and worked with a numeric control system. Decorative rings in polished cast brass. Top in multilayer wood veneered in matt Dark Wengé Dyed Carbalho.

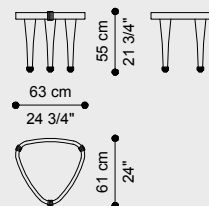
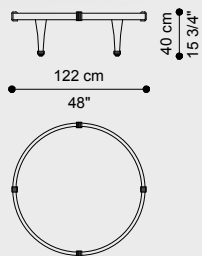

MATT DARK WENGÉ  
DYED CARBALHO  
VENEERED



## AKAN SIDE TABLE

*With its ethnic and sophisticated charm, the Akan side table shows on the top a typical decoration inspired by an African mask and reproduced in black and ivory marbles, with gold details. According to the traditional view of the Akan people, gold is a real living being with a strong and fearful spirit, and due to this its exceptional nature is considered with respect and veneration.*



**E.AKA.232.AHX**

### COMPOSITION

Side table with structure in solid beech wood. Legs turned and worked with a numeric control system. Patinated Gold Liquid Metal Lacquered finishing. Top with inlaid decoration of Noir Saint Laurent and Calacatta Oro marbles and polished brass.

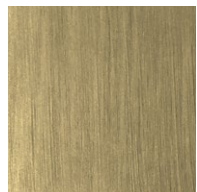
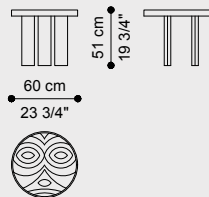

PATINATED GOLD LIQUID  
METAL LACQUERED

# PALMIRA MODULAR BOOKCASE

*Bold and distinctive, the Palmira modular bookcase plays with the combination of the dark bronze and polished brass finishings of the vertical structure and the warmth of the Carbalho essence dyed Dark Brown that features the shelves to create a dynamic ensemble. The light structure and slender lines make it perfect as a room divider.*

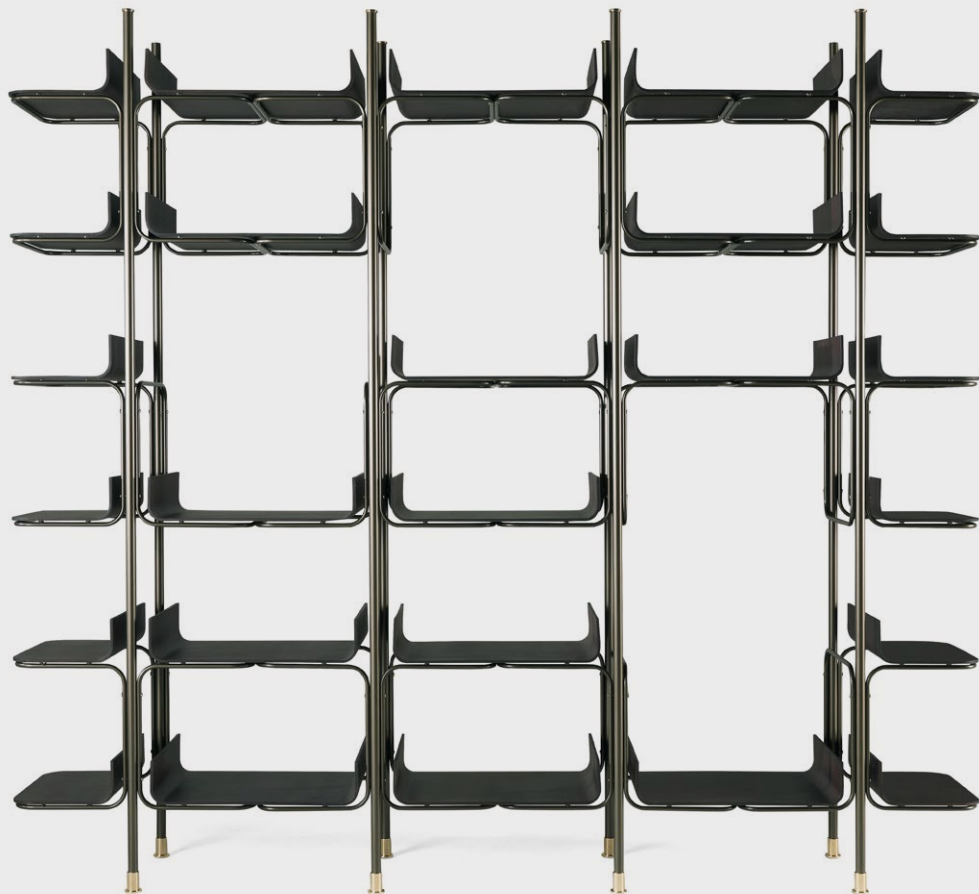

## E.PAL.542

### COMPOSITION

Modular bookcase with uprights in iron with Dark Bronze finishing. Adjustable mounting tips in polished brass. Horizontal modules in iron with Dark Bronze finishing, in three types guaranteeing customised settings, assembled with golden screws. Removable shelves in curved multilayer wood veneered in matt Dark Wengé Dyed Carbalho, attached to the structure by a magnetic system.



MATT DARK WENGÉ  
DYED CARBALHO  
VENEERED



DARK BRONZE

### E.PAL.542.AIX

Pair of uprights with wall mounting

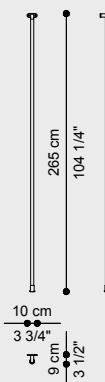

### E.PAL.542.BIX

Pair of uprights without wall mounting



### E.PAL.542.CIX

"C" shape end module

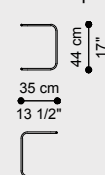

### E.PAL.542.DIX

"L" shape end module

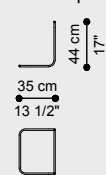

### E.PAL.542.EIX

"C" shape module

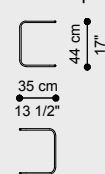

### E.PAL.542.FIX

"L" shape module

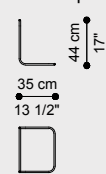

### E.PAL.542.GGX

End shelf

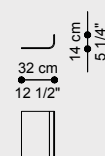

### E.PAL.542.HGX

Shelf

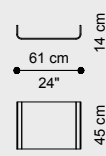

### COMPOSITION A

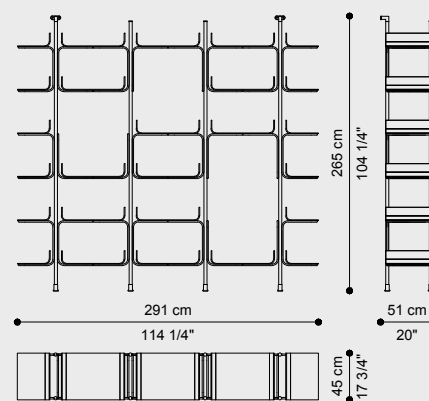

### COMPOSITION B

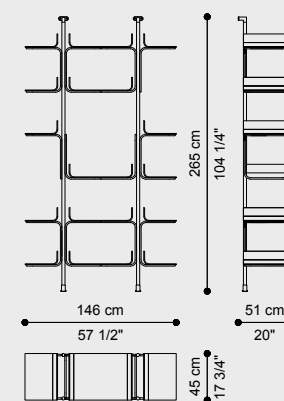

## KYOTO FLOOR LAMP

*Evocative and scenographic, the Kyoto lamp, thanks to its soft and delicate light, allows you to create a magic atmosphere. The bamboo cane-shaped shades are in transparent bronzed glass, while the structure is in metal with a Glossy Gold finish.*



**E.KYO.621.AMX**

### COMPOSITION

Floor lamp with 3-light system, all with strip LED 17,3W - 24V - 77W - 8661lm - 3000K. Shades shaped like bamboo canes in transparent bronzed glass on a metal structure with Glossy Gold finishing. Cables in gold fabric.

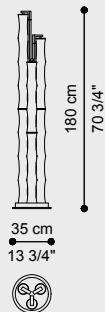



**E.VAR.571.AMX**

**COMPOSITION**

Rug in hand-tufted wool and bamboo silk.  
Pattern with ETRO floral motif.  
Colour Vintage beige.

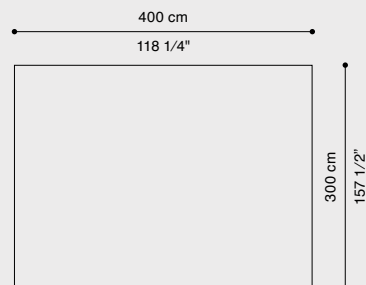

# DINING ROOM



# TANGERI DINING TABLE

*Tangeri is a 1950s vintage-inspired dining table, with references to Milanese culture and the work of designer Gabriella Crespi. The dominant presence of wood, specifically the new Canaletto walnut essence, is made lighter and brighter by the border with gold profile, a detail that illuminates and embellishes the whole making it elegant and versatile.*

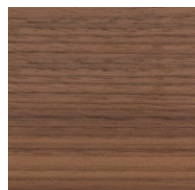
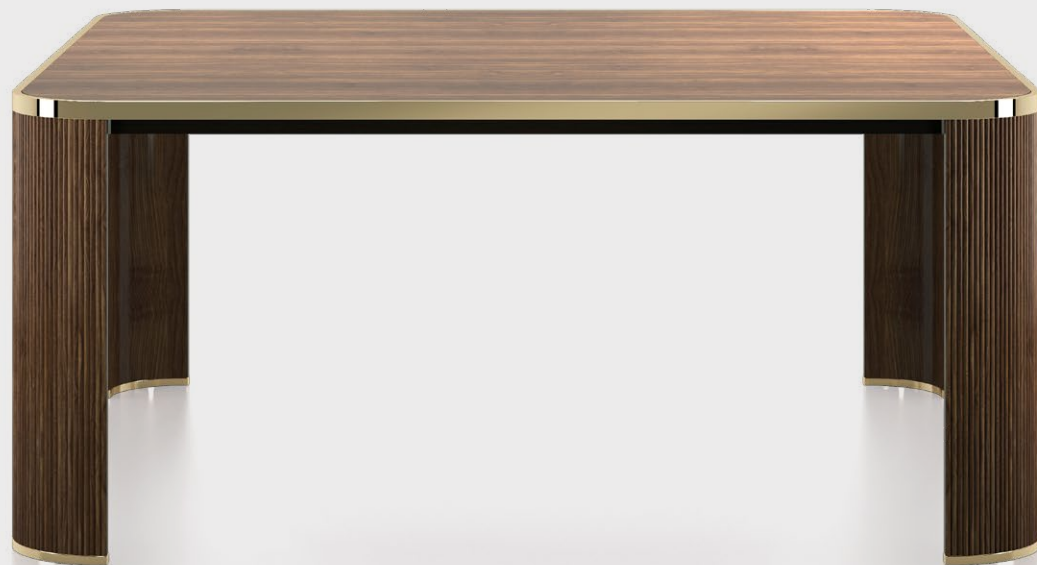

VENEERED CANALETTO  
WALNUT

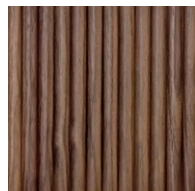

MILLED CANALETTO  
WALNUT



GOLD

## E.TAN.121.AGX

### COMPOSITION

Square dining table with structure in multilayer wood. Curved legs veneered in semi-glossy Canaletto Walnut on the inside and finished in semi-glossy Milled Canaletto Walnut on the outside. Metal feet with Gold finishing. Top veneered in semi-glossy Canaletto Walnut, bordered with metal profile with Gold finishing.

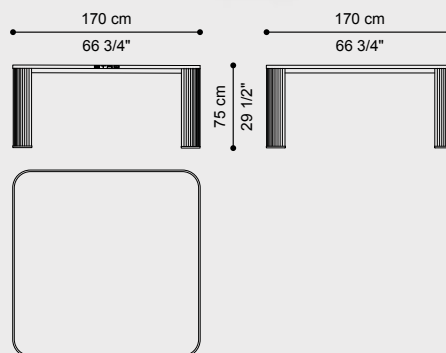

# SHIRAZ CHAIR

*The Paisley symbol is the protagonist of a piece of furniture with an iconic charm. In the Shiraz chair, the famous teardrop motif lends its characteristic shape to the backrest and seat, where the combination of two elements creates the mystical sign of the tao. In the encounter between Yin and Yang, between feminine and masculine, the light and luminous appeal of the Shiraz chair is enriched with new and profound meanings.*



Leather CUIR  
col. 4 Camel  
cat. A



Jacquard fabric ZULU  
col. 2 Cappuccino  
cat. A



GOLD



**E.SHI.131.AA1**

## COMPOSITION

Chair with structure in iron tubing with gold finishing.  
Seat and backrest with double Paisley in curved multilayer wood and expansive polyurethane foam. Upholstery in jacquard fabric cat. A Zulu col. 2 Cappuccino and leather cat. A Cuir col. 4 Camel.

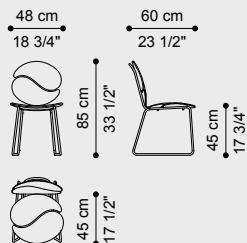

# TANGERI SIDEBOARD

*A compact and linear volume for a sideboard inspired by the '50s and characterized by the strong, warm and decisive presence of wood. The golden details make the whole more elegant and sophisticated, allowing it to be inserted in environments of different styles.*

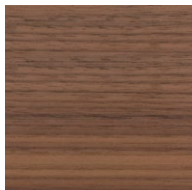

VENEERED CANALETTO WALNUT

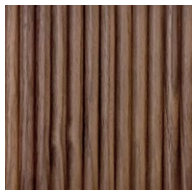

MILLED CANALETTO WALNUT



GOLD

## E.TAN.113.AGX

### COMPOSITION

Sideboard with structure in curved multilayer wood.  
Top, inner parts and base veneered in semi-glossy Canaletto Walnut.  
Back and doors in solid wood finished in semi-glossy Milled Canaletto Walnut and bordered with metal profile with gold finishing.

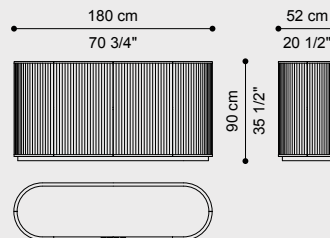



# RICHAT MIRROR

*Essential yet rich in meanings: the spherical shape of the Richat mirror is a powerful detail that livens up the wall contributing to lend the environment a sophisticated and elegant character.*

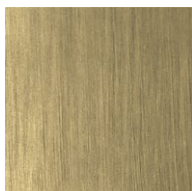
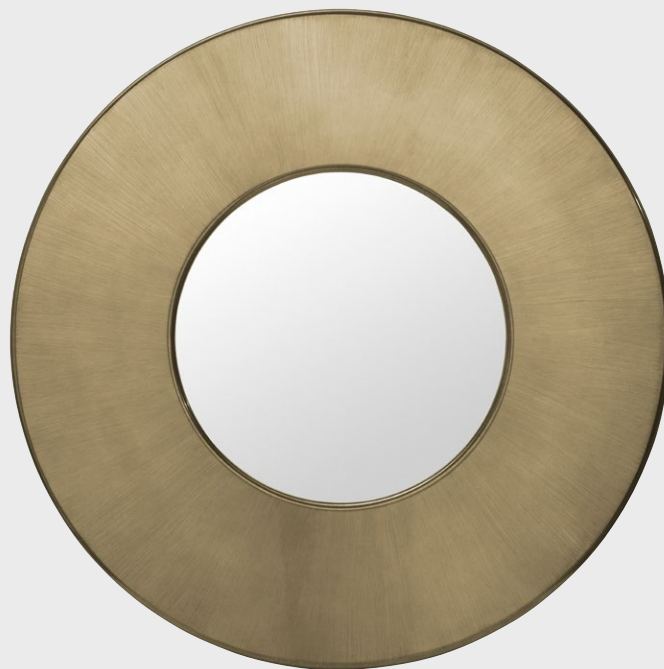

PATINATED GOLD  
LIQUID METAL  
LACQUERED

**E.RIC.511.AMX**

## COMPOSITION

Mirror with structure in MDF lacquered Patinated Gold Liquid Metal, worked with a numeric control system. Natural mirror. Back in MDF lacquered Black Matt colour.

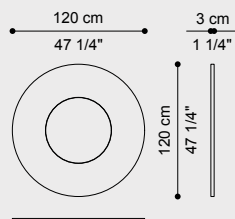

# TIBESTI CABINET

A new, Deco style cabinet, characterized by precious inlays in brass with a pattern that incorporates the "E", initial letter of the Etro logo. Legs, base, doors and sides are in smoked eucalyptus frisé wood.



SMOKED EUCALYPTUS  
FRISÉ VENEERED



BRASS AND SMOKED  
EUCALYPTUS FRISÉ  
INLAY

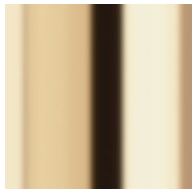

POLISHED BRASS



## E.TIB.116.AGX

### COMPOSITION

Cabinet with structure in multilayer wood entirely veneered in glossy Smoked Eucalyptus Frisé. Tips and corner elements in polished brass.  
Doors decorated with "E" pattern by inlay of Eucalyptus essence and polished brass.

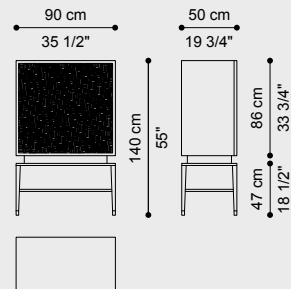

# SHAH ARMCHAIR

*Shah is a welcoming and evocative armchair that celebrates ETRO Home Interiors' eclectic soul. The ethnic inspiration, already present in the name that refers to the kings of the Persian tradition, is found in the cushion resting on the seat, recalling the Ottoman poufs, in the essential lines of the dark wood structure and in the velvet upholstery. The institutional character can be found in the detail of the Pegasus, historical symbol of the brand, applied on the back. The silk tassels on the seat cushion add a classic twist, confirming the versatile personality of the armchair.*



**E.SHH.228.ADX**

## COMPOSITION

Armchair with structure in solid beech wood dyed matt Dark Wengé, turned and worked with a numeric control system. Decorative Pegasus in laser-cut brass foil on the back of the backrest. Seat in multilayer wood and variable thickness high density expansive polyurethane foam. Upholstery in velvet cat. A Genova col. 4 Khaki, piping included. Decorative tassels in silk in colours matching upholstery fabric. Backrest in curved multilayer wood dyed matt Dark Wengé and variable thickness high density expansive polyurethane foam. Upholstery in velvet cat. A Genova col. 4 Khaki.

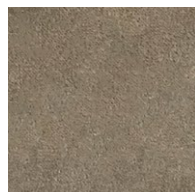
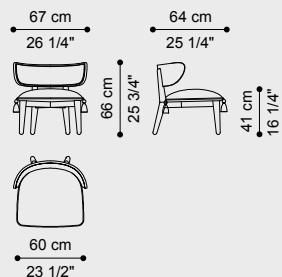

Velvet GENOVA  
col. 4 Khaki cat. A

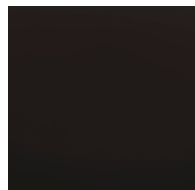

DARK WENGÉ DYED

# CHANDRA LOW TABLE

*A game of elements with a flowing and harmonious shape distinguishes the Chandra side table. The elaborate structure, composed of tubular elements with a rounded base, presents a succession of empty and velvet-covered modules: a detail that lends a special dynamism to the piece. The top is covered with an iconic fabric with Paisley print, in a neutral and delicate shade in line with the most intimate and sophisticated mood of the collection.*



Jacquard fabric  
DEOSAI col. 3 Mystic  
cat. A



Velvet VENEZIA  
col. 22 Caramel cat. A

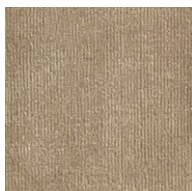

Velvet VENEZIA  
col. 23 Rope cat. A

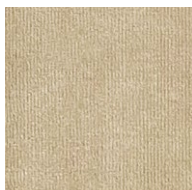

Velvet VENEZIA  
col. 24 Ivory cat. A

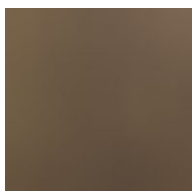

DARK BRONZE



## E.CHN.232.ADI

### COMPOSITION

Low table with structure in iron tubing with Dark Bronze finishing.  
Top support in iron with Dark Bronze finishing. Top in multilayer wood covered in jacquard fabric cat. A Deosai col. 3 Mystic and finished with a sheet of extra clear glass. Side panels in multilayer wood covered in velvet cat. A Venezia col. 22 Caramel, col. 23 Rope and col. 24 Ivory.

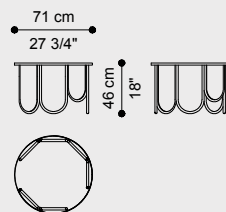

# CHAGALL CHANDELIER



## E.CHA.611.BMX

### COMPOSITION

Chandelier with 3 E27 LED bulbs.  
Shades in transparent bronze blown glass  
with arabesque patterns.  
Ceiling rose and metallic parts with glossy  
gold finishing. Cables in gold fabric.

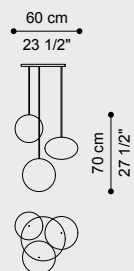

# CHAGALL TABLE LAMP



**E.CHA.631.AMX**

## COMPOSITION

Table lamp with 3 E27 LED bulbs.  
Shades in transparent bronze blown glass  
with arabesque patterns.  
Base and metallic parts with glossy gold  
finishing. Cables in gold fabric.

40 cm  
15 3/4"

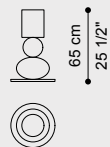



**E.VAR.571.AMX**

**COMPOSITION**

Rug in hand-tufted wool and bamboo silk.  
Pattern with ETRO floral motif.  
Colour Vintage beige.

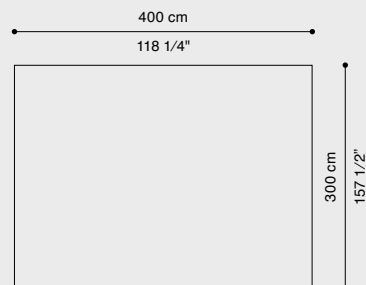

# BEDROOM





# DELFI BED

A bed with a regal and fairy-tale charm, in which the frame in polished brass shaped like bamboo canes meets the timeless elegance of the capitonné manufacturing. The combination of different iconic fabrics from the ETRO Home Interiors line embellishes and enriches the bed, allowing the creation of a sleeping corner with an evocative and refined atmosphere.



Velvet GENOVA  
col. 4 Khaki  
cat. A



Jacquard fabric  
DECCAN col. 3 Beige  
cat. A



POLISHED BRASS

**E.DEL.312.ADJ**

Bed for mattress 180 x 200 cm

**E.COM.831.ADX**

Bedcover

## COMPOSITION

Bed with capitonné headboard on panel in multilayer wood and variable thickness high density expansive polyurethane foam. Hollowed-out button in polished brass and upholstery in velvet cat. A Genova col. 4 Khaki. Frame in polished brass, shaped like bamboo canes through handcrafted hot working metal process.

Roll cushions in variable thickness high density expansive polyurethane foam. Upholstery in jacquard fabric cat. A Deccan col. 3 Beige, piping included.

Bed frame in multilayer wood and variable thickness high density expansive polyurethane foam. Upholstery in velvet cat. A Genova col. 4 Khaki.

Feet in polished brass, shaped like bamboo canes through handcrafted hot working metal process.

Bedcover in velvet cat. A Genova col. 4 Khaki.

"Soffio" slatted bed base included.

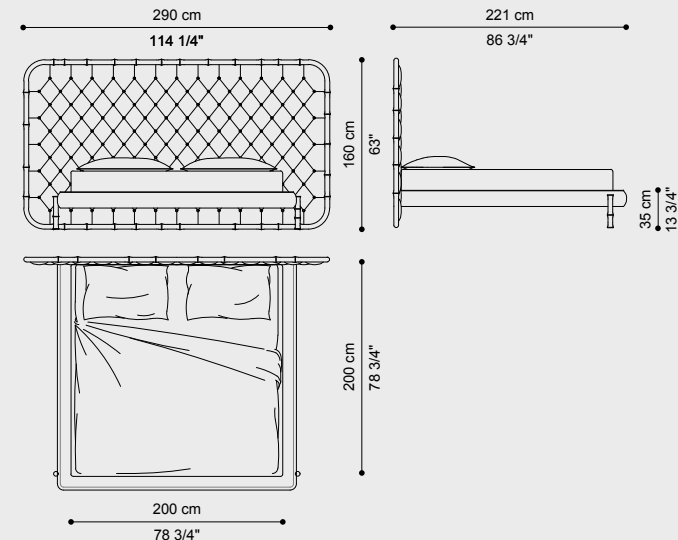

**E.DEL.312.B**

Bed for mattress 200 x 200 cm

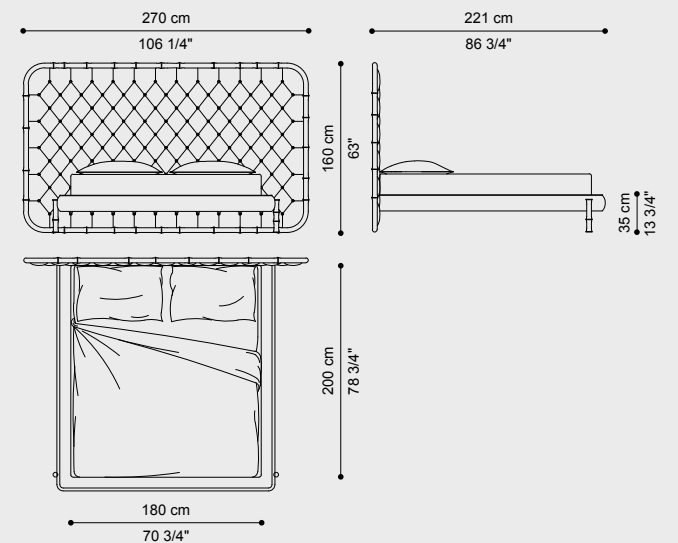

**E.DEL.312.A**

Bed for mattress 180 x 200 cm

## DELHI NIGHT TABLE

Functional and elegant, the night tables of the Delhi line are characterized by a light brass structure and a precious upholstery in the typical fabrics of the ETRO Home Interiors collection. The knobs in polished brass with silk decorative tassels enrich the ensemble, adding a classic and sophisticated note.



Jacquard fabric ZULU  
col. 3 Sand  
cat. A



POLISHED BRASS

### E. DEH. 321. ADX

#### COMPOSITION

Night table with structure in polished brass. Sides and top in bronzed glass, fixed to the structure.

Storage unit with drawers covered on the outside in jacquard fabric cat. A Zulu col. 3 Sand. Drawers with inner cover in black microfibre.

Knobs in polished brass, with double frill decorative tassels in silk, in colours matching with upholstery fabric.

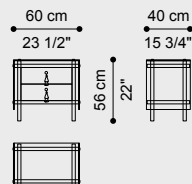

# DELHI DRAWER UNIT

*The iconic Delhi chest of drawers is a fascinating piece of furniture characterized by a light brass structure and a precious upholstery in the typical fabrics of the ETRO Home Interiors collection. This version of the chest of drawers without glass doors is even more functional, maintaining the intimate and refined mood that distinguishes the line.*

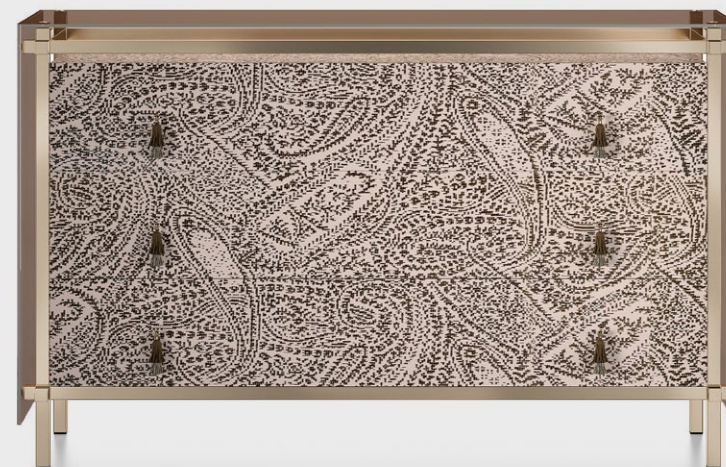

Jacquard fabric ZULU  
col. 3 Sand  
cat. A



POLISHED BRASS

## E. DEH. 331. ADX

### COMPOSITION

Drawer unit with structure in polished brass. Sides and top in bronzed glass, fixed to the structure.

Storage unit with drawers covered on the outside in jacquard fabric cat. A Zulu col. 3 Sand. Drawers with inner cover in black microfibre.

Knobs in polished brass, with double frill decorative tassels in silk, in colours matching with upholstery fabric.

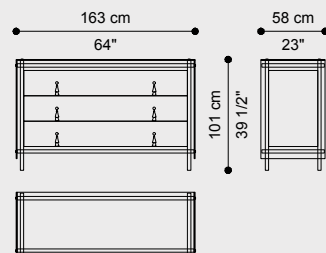

# MERIAM POUF

A decorative piece of furniture with exotic suggestions, Meriam pouf is presented with seat upholstery in Deccan jacquard fabric and embellished with golden studs and a fluted gold lacquered base. In this new version the pouf is also a precious storage element that can be opened by lifting the seat cushion.



Jacquard fabric  
DECCAN col. 3 Beige  
cat. A

Velvet VENEZIA  
col. 23 Rope  
cat. A

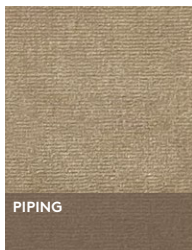

Velvet VENEZIA  
col. 22 Caramel  
cat. A



SEMI-GLOSSY  
GOLD LACQUERED



## E.MEI.562.ADX

### COMPOSITION

Pouf with storage openable by lifting the seat cushion.

Structure in multilayer wood and variable thickness high density expansive polyurethane foam. External and internal upholstery in jacquard fabric cat. A Deccan col. 3 Beige. Seat upholstery in velvet cat. A Venezia col. 23 Rope. Piping in velvet cat. A Venezia col. 22 Caramel. Golden decorative nails on bottom.

Handle in polished brass.

Base in Gold Lacquered MDF, grooved with a numeric control system.

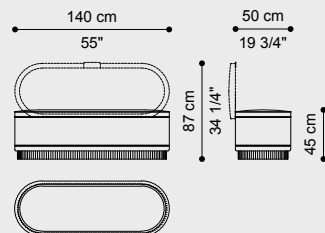

# MERIAM POUF

*A decorative piece of furniture with exotic suggestions, Meriam pouf is presented with a new velvet upholstery with pastel tones. The pouf is embellished with golden decorative studs and a fluted gold lacquered base.*



Jacquard fabric  
DECCAN col. 3 Beige  
cat. A

Velvet VENEZIA  
col. 22 Caramel  
cat. A



Velvet VENEZIA  
col. 23 Rope  
cat. A



SEMI-GLOSSY  
GOLD LACQUERED



**E. MEI. 222. ADX**

## COMPOSITION

Pouf with structure in multilayer wood and variable thickness high density expansive polyurethane foam. Upholstery in jacquard fabric cat. A Deccan col. 3 Beige. Seat upholstery in velvet cat. A Venezia col. 22 Caramel. Piping in velvet cat. A Venezia col. 23 Rope. Decoration with ETRO motif with golden nails. Golden decorative nails on bottom. Base in Gold Lacquered MDF, grooved with a numeric control system.



# BERENICE CHAISE LONGUE

*In perfect balance between purity of lines and comfort, Berenice chaise longue embodies the concept of coziness thanks to the seat modeled according to the natural lines of the body. The light structure with bronzed finishing and the decorative rings in cast brass are linked to the deepest identity of the brand.*



CLOAK VELVET  
col. 2 Greige  
cat. B



Velvet GENOVA  
col. 4 Khaki  
cat. A

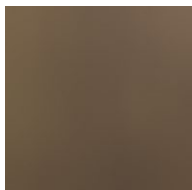

DARK BRONZE

## E.BER.224.AEX

### COMPOSITION

Chaise longue with structure in iron tubing with Dark Bronze finishing.  
Decorative rings in polished cast brass.  
Seat in curved multilayer wood and variable thickness high density expansive polyurethane foam. Upholstery in velvet cat. B Cloak Velvet col. 2 Greige.  
Headrest cushion in goose down.  
Removable upholstery and piping in velvet cat. A Genova col. 4 Khaki, piping included.

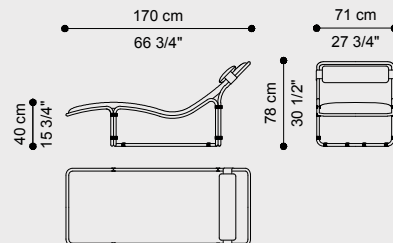

# CHANDRA LOW TABLE

*A game of elements with a flowing and harmonious shape distinguishes the Chandra side table. The elaborate structure, composed of tubular elements with a rounded base, presents a succession of empty and wood-covered modules: a detail that lends a special dynamism to the piece, in line with the most intimate and sophisticated mood of the collection.*



MATT DARK WENGÉ  
DYED CARBALHO  
VENEERED

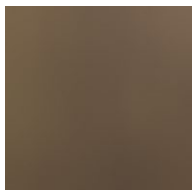

DARK BRONZE

**E.CHN.232.AIG**

## COMPOSITION

Side table with structure in iron tubing with Dark Bronze finishing. Top support in iron with Dark Bronze finishing. Top in multilayer wood veneered in matt Dark Wengé Dyed Carbalho. Side panels in multilayer wood veneered in matt Dark Wengé Dyed Carbalho.

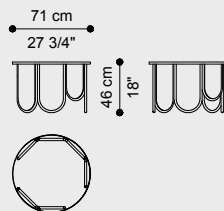

# WOODSTOCK DRESSING TABLE

Simple lines and sophisticated details for the Woodstock dressing table, characterized by the intense shades of the Carbalho essence contrasting with the tips and the paisley decorative elements in polished brass.

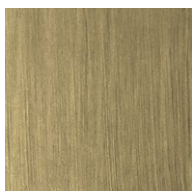

PATINATED GOLD LIQUID METAL LACQUERED



MATT DARK WENGÉ DYED CARBALHO VENEERED

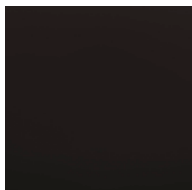

DARK WENGÉ DYED



POLISHED BRASS

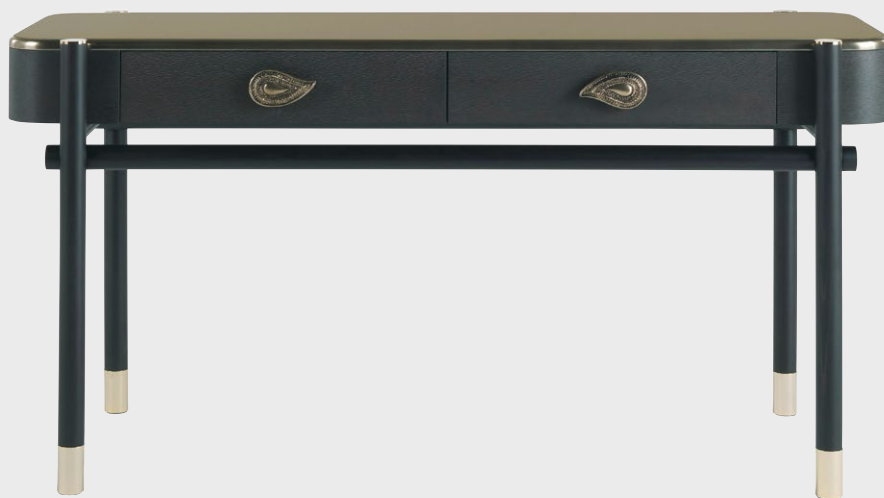

**E.WOO.341.AGX**

## COMPOSITION

Dressing table with structure in solid beech wood dyed matt Dark Wengé, turned and worked with a numeric control system. Tips in polished brass. Top lacquered Patinated Gold Liquid Metal, with drawers in multilayer wood veneered in matt Dark Wengé Dyed Carbalho. Drawers with inner cover in black microfibre. Paisley handles in polished cast brass.

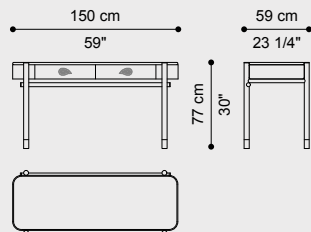



# DELFI MIRROR

*Bamboo cane: an element of natural inspiration that becomes the main protagonist of an elegant and sophisticated mirror. Delfi is a fascinating element that integrates and enriches the living room or bedroom furniture with its exotic touch.*



NATURAL BEVELLED MIRROR



POLISHED BRASS

**E.DEL.511.BMX**

## COMPOSITION

Mirror with frame in polished brass, shaped like bamboo canes through handcrafted hot working metal process.  
Natural bevelled mirror, attached to a panel of multilayer wood with back covered in logo printed canvas.

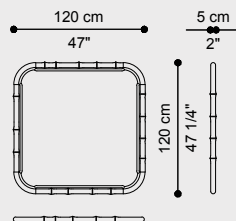

# MCKENZIE SUSPENSION LAMP

*The McKenzie suspension lamp, with glass lampshades in a new amber shade, add a note in perfect "One Thousand and One Nights" style, accentuating the sensual and fairytale atmosphere of the interior design.*



**E.MCK.611.DMX**

## COMPOSITION

2-bulb suspension lamp with Strip LED 3000K 24V with shades in transparent amber coloured glass.  
Ceiling rose and metallic parts with polished light gold finishing.

21 cm  
8 1/4"

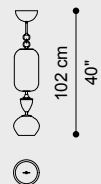



**E.VAR.571.AMX**

**COMPOSITION**

Rug in hand-tufted wool and bamboo silk.  
Pattern with ETRO floral motif.  
Colour Vintage beige.

